

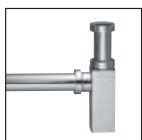

pag 534



pag 533



pag 350



pag 344



pag 329



pag 314



pag 349



pag 375

Kiki



IT - Porta & Bini si riserva il diritto di apportare eventuali modifiche ai propri prodotti senza preavviso. Le dimensioni raffigurate all'interno delle rappresentazioni grafiche sono da ritenersi indicative e soggette a possibili variazioni. In caso di domande si prega di contattare il proprio fornitore autorizzato Porta & Bini.

GB - Porta & Bini has the right to modify its products without any notice. All dimensions are based on original specification and are subject to change and variation. Please consult your Porta & Bini Design Associate for current specifications.

FR - Porta & Bini se réserve le droit de modifier ses propres produits sans préavis. Les dimensions indiquées dans les représentations graphiques sont données à titre indicatif et sont susceptibles d'être modifiées. En cas de doutes veuillez contacter votre livreur autorisé Porta & Bini.

DE - Das Unternehmen Porta & Bini behält sich das Recht vor, Änderungen an seinen Produkten ohne vorherige Ankündigung vorzunehmen. Die in den grafischen Darstellungen dargestellten Abmessungen sind als Richtwerte zu betrachten und unterliegen möglichen Abweichungen. Bei Fragen wenden Sie sich bitte an Ihren, von Porta & Bini autorisierten Lieferanten.

KIKI



IT - Gli articoli della serie Kiki sono disponibili nelle finiture sotto indicate:

CR Cromo NP Nero opaco

IMPORTANTE: Nella cura dei prodotti Porta & Bini si devono utilizzare soltanto i prodotti di pulizia che sono espressamente previsti per questo campo d'impiego. Non utilizzare prodotti ausiliari e attrezzi per la pulizia con effetto abrasivo, come abrasivi inadatti, spugne e panni in microfibra.

GB - The articles included in Kiki series are available in the following finishings:

CR Chrome NP Black matt

IMPORTANT: With regard to caring for the Porta & Bini products, only use cleaning material which is explicitly provided for this type of application. Never use cleaning materials or appliances with an abrasive effect, such as unsuitable cleaning powders, sponge pads or micro fibre cloths.

FR - Les articles de la série Kiki sont disponibles en finitions indiquées ci-dessous :

CR Chrome NP Noir opaque

IMPORTANT : Lors de l'entretien des articles Porta & Bini, seuls les produits de nettoyage expressément prévus pour ce type d'entretien doivent être utilisés. Ne pas utiliser d'autres produits ou d'outils de nettoyage ayant un effet abrasif, tels que les abrasifs inappropriés, éponges ou chiffons en microfibra.

DE - Die Artikel der Serie Kiki sind in den unten aufgeführten Fertigbearbeitungen erhältlich:

CR Chrom NP Mattschwarz

WICHTIG: Für die Pflege der Produkte Porta & Bini dürfen nur die Reinigungsmittel verwendet werden, welche ausdrücklich für diesen Anwendungsbereich vorgesehen sind. Keine abrasiven Hilfsprodukte und Reinigungswerkzeuge verwenden, wie ungeeignete Schleifmittel, Schwämme und Mikrofasertücher.

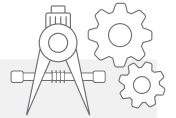

IT - SPECIFICHE TECNICHE

- > Temperatura di utilizzo massima 80°C, consigliata 60°C.
- > Pressione di alimentazione ottimale 3 bar continui.
- > Differenza pressione massima acqua calda/fredda 1 bar consigliata la minima possibile.
- > Nel caso di pressioni oltre i 5 bar, è consigliabile installare un riduttore di pressione.

NOTA: I tubetti flessibili vengono forniti come dotazione standard per una più facile installazione; i tubetti rigidi sono disponibili come un accessorio opzionale o su previa richiesta.

Per garantire l'ottimale funzionamento del prodotto si consiglia l'installazione di rubinetti filtro sottolavabo ispezionabili Porta & Bini articoli: 00538, 00539 e 00540.

GB - TECHNICAL SPECIFICATION

- > Temperature range max 80°C, recommended 60°C.
- > Optimal water supply pressure 3 bar continual.
- > Difference of hot/cold pressure max 1 bar recommended minimum possible.
- > In the event of pressure over 5 bar, install a centralized pressure reducer.

NOTE: Stainless steel hoses are provided as standard equipment for easy installation; copper supply tubes are available as an optional accessory or with advance notice.

In order to allow optimal product operation is recommended to connect hot and cold waterlines to the angle stop filter valves Porta & Bini items code: 00538, 00539 and 00540.

FR - SPÉCIFICATIONS TECHNIQUES

- > Température d'utilisation maximale 80°C, conseillée 60°C.
- > Pression d'alimentation optimale 3 bar continue.
- > Différence de pression max de l'eau chaude/froide 1 bar, la différence conseillée - la plus petite possible.
- > En cas des pressions supérieures à 5 bar, il est conseillé d'installer un réducteur de pression.

NOTE : Les tubes flexibles sont fournis avec l'équipement standard pour une installation plus facile ; les tubes rigides sont disponibles en option ou sur demande.

Afin de garantir le fonctionnement optimal du produit, il est conseillé d'installer les robinets avec filtre sous lavabo inspectables Porta & Bini articles: 00538, 00539 et 00540.

DE - TECHNISCHE SPEZIFIKATIONEN

- > Maximale Gebrauchstemperatur 80°C, empfohlene Temperatur 60°C.
- > Der optimale Versorgungsdruck liegt bei durchgehend 3 bar.
- > Als maximaler möglicher Druckunterschied bei Heiß-/Kaltwasser wird als Mindestwert 1 bar empfohlen.
- > Bei einem Wasserdruck von über 5 bar ist es ratsam, ein Druckminderventil einzubauen.

ANMERKUNG: Die Schläuche werden zur einfacheren Installation als Standardausrüstung mitgeliefert; Die starren Rohrleitungen sind als optionales Zubehör oder auf vorhergehende Anfrage erhältlich.

Um die optimale Funktionsfähigkeit des Produktes zu gewährleisten, empfiehlt sich die Installation von inspezierbaren Untertisch-Filtereckventilen der Firma Porta & Bini, Artikel: 00538, 00539 und 00540.

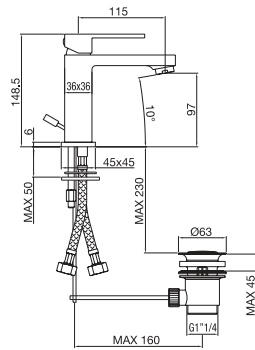

34110..

Finiture - Finishes

CR

NP

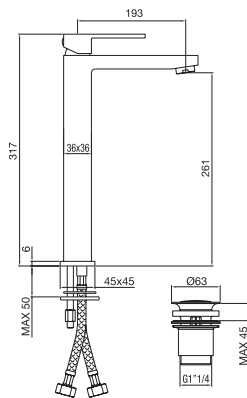

34191..

Finiture - Finishes

CR

NP

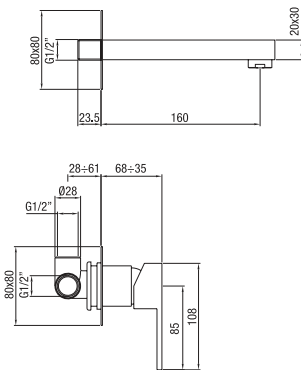

34124..

Finiture - Finishes

CR

NP

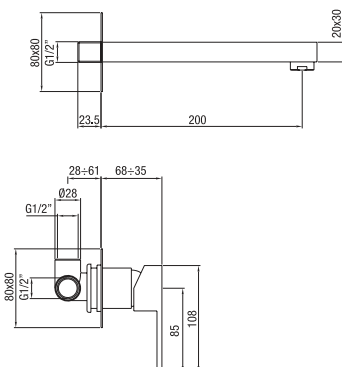

34125..

Finiture - Finishes

CR

NP

IT - Monocomando lavabo con scarico automatico.
 GB - Single lever basin mixer with pop up waste.
 FR - Monocommande lavabo avec décharge automatique.
 DE - Einhebelmischer für Waschbecken mit automatischem Ablauf.

IT - Monocomando lavabo alto con piletta click-clack.
 GB - Single lever high basin mixer with click-clack outlet.
 FR - Monocommande lavabo haut avec bonde clic-clac.
 DE - Hoher Einhebelmischer für Waschbecken mit Klick-Klack-Ablaufgarnitur.

IT - Monocomando lavabo a muro due parti. L 160 mm.
 GB - Wall single lever basin mixer two parts. L 160 mm.
 FR - Monocommande lavabo montage mural deux parties. L 160 mm.
 DE - Einhebelmischer Waschbecken Wandmontage zweiteilig. L 160 mm.

IT - Monocomando lavabo a muro due parti. L 200 mm.
 GB - Wall single lever basin mixer two parts. L 200 mm.
 FR - Monocommande lavabo montage mural deux parties. L 200 mm.
 DE - Einhebelmischer Waschbecken Wandmontage zweiteilig. L 200 mm.

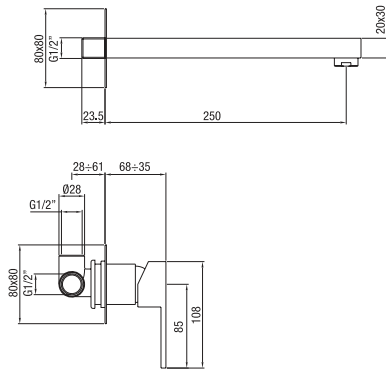

IT - Monocomando lavabo a muro due parti. L 250 mm.
 GB - Wall single lever basin mixer two parts. L 250 mm.
 FR - Monocommande lavabo montage mural deux parties. L 250 mm.
 DE - Einhebelmischer Waschbecken Wandmontage zweiteilig. L 250 mm.



34126..

Finiture - Finishes

CR

NP

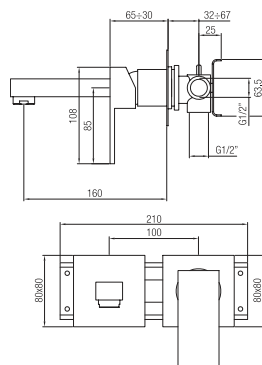

IT - Monocomando lavabo a muro connessione ponte. L 160 mm.
 GB - Wall single lever basin mixer bridge connection. L 160 mm.
 FR - Monocommande lavabo montage mural connexion pont. L 160 mm.
 DE - Einhebelmischer Waschbecken Wandmontage Brückenanschluss. L 160 mm.



34127..

Finiture - Finishes

CR

NP

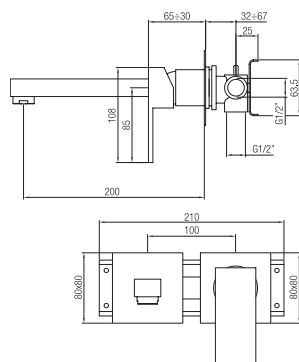

IT - Monocomando lavabo a muro connessione ponte. L 200 mm.
 GB - Wall single lever basin mixer bridge connection. L 200 mm.
 FR - Monocommande lavabo montage mural connexion pont. L 200 mm.
 DE - Einhebelmischer Waschbecken Wandmontage Brückenanschluss. L 200 mm.



34128..

Finiture - Finishes

CR

NP

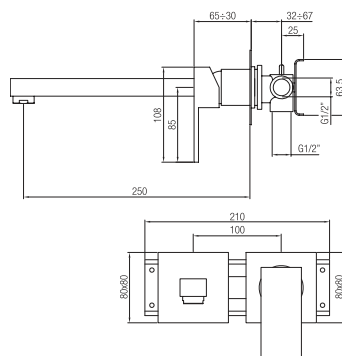

IT - Monocomando lavabo a muro connessione ponte. L 250 mm.
 GB - Wall single lever basin mixer bridge connection. L 250 mm.
 FR - Monocommande lavabo montage mural connexion pont. L 250 mm.
 DE - Einhebelmischer Waschbecken Wandmontage Brückenanschluss. L 250 mm.



34129..

Finiture - Finishes

CR

NP

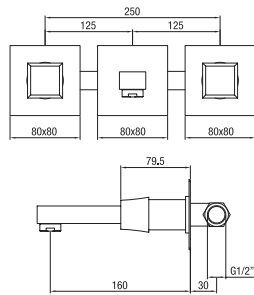

34542..

Finiture - Finishes

CR

NP

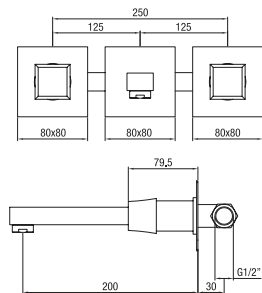

34543..

Finiture - Finishes

CR

NP

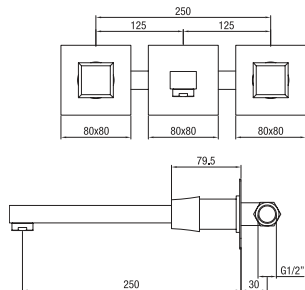

34544..

Finiture - Finishes

CR

NP

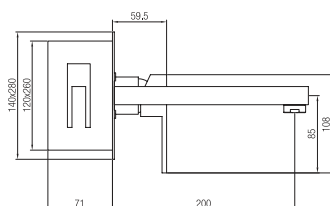

34115..

Finiture - Finishes

CR

NP

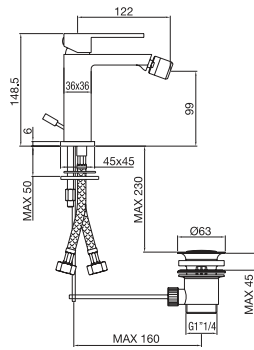

34120..

Finiture - Finishes

CR

NP



34100..

Finiture - Finishes

CR

NP

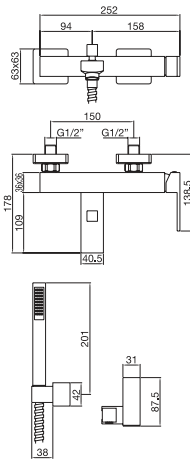

34123..

Finiture - Finishes

CR

NP

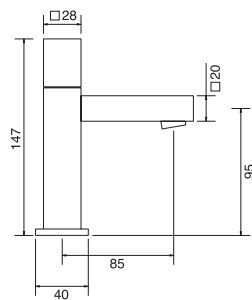

34180..

Finiture - Finishes

CR

NP

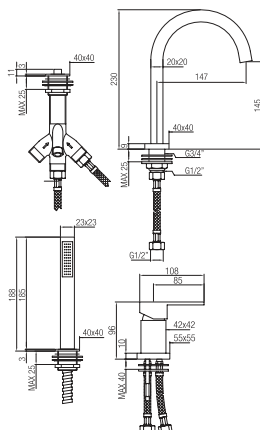

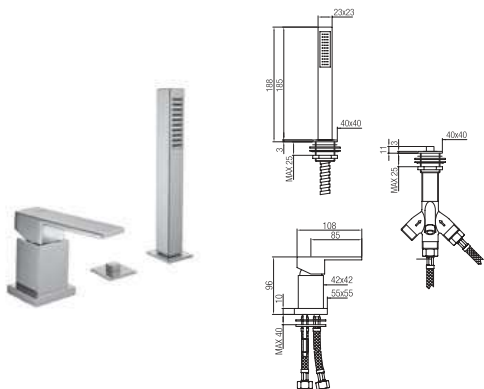

34181..

Finiture - Finishes

CR

NP

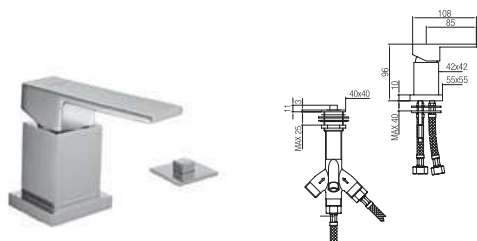

34182..

Finiture - Finishes

CR

NP

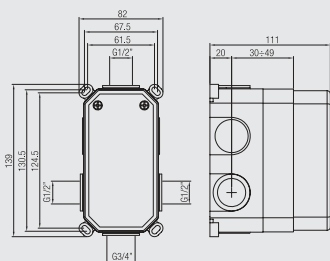

IT - Cassetta da incasso a muro universale.
 GB - Universal built-in shower box.
 FR - Boîtier encastrable montage mural universel.
 DE - Universal-Einbauspülkasten Wandmontage.

01BOXNC

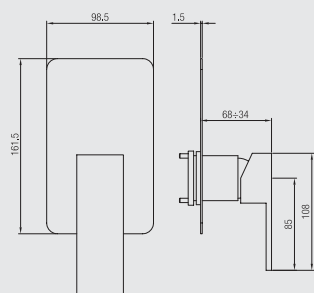
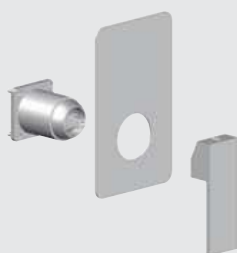

IT - Parti esterne monocomando doccia incasso.
 GB - External parts built-in shower mixer.
 FR - Parties externes monocommande douche encastrément.
 DE - Externe Bestandteile Einbau-Einhebelmischer für Duschen.



34166..

Finiture - Finishes

CR

NP

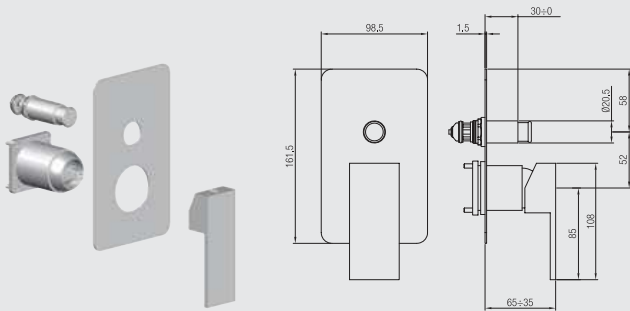

IT - Parti esterne monocomando doccia incasso con deviatore.
 GB - External parts built-in shower mixer with diverter.
 FR - Parties externes monocommande douche encastrément avec inverseur.
 DE - Externe Bestandteile Einbau-Einhebelmischer für Duschen mit Umstellventil.



34167..

Finiture - Finishes

CR

NP

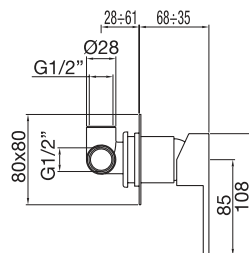

IT - Monocomando doccia incasso piastra piccola quadrata.
 GB - Built-in shower mixer small square plate.
 FR - Monocommande douche encastrément plaque petite carrée.
 DE - Einhebelmischer für Duschen Einbau, kleine quadratische Platte.



34138..

Finiture - Finishes

CR

NP

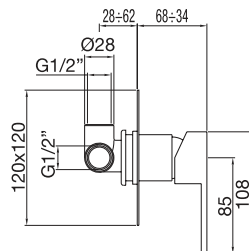

IT - Monocomando doccia incasso piastra slim.
 GB - Built-in shower mixer slim plate.
 FR - Monocommande douche encastrément plaque slim.
 DE - Einhebelmischer für Duschen Einbau Slim Platte.



34133..

Finiture - Finishes

CR

NP

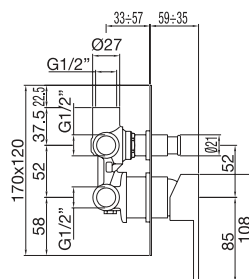

IT - Monocomando doccia incasso con deviatore piastra slim.
 GB - Built-in shower mixer with diverter slim plate.
 FR - Monocommande douche encastrément avec inverseur plaque slim.
 DE - Einhebelmischer für Duschen, Einbau mit Umstellventil Slim Platte.



34134..

Finiture - Finishes

CR

NP

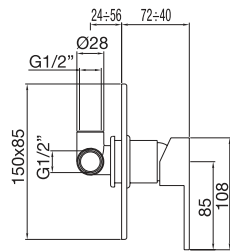

34330..

Finiture - Finishes

CR

NP

IT - Monocomando doccia incasso con deviatore piastra 150x85.

GB - Built-in shower mixer with diverter plate 150x85.

FR - Monocommande douche encastré avec inverseur plaque 150x85.

DE - Einhebelmischer für Duschen, Einbau mit Umstellventil, Platte 150x85.

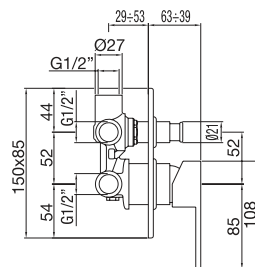

34331..

Finiture - Finishes

CR

NP

IT - Monocomando doccia incasso con deviatore tre uscite.

GB - Built-in shower mixer with diverter three outlets.

FR - Monocommande douche encastré avec inverseur trois sorties.

DE - Einhebelmischer für Duschen Einbau mit Umstellventil 3 Ausgänge.

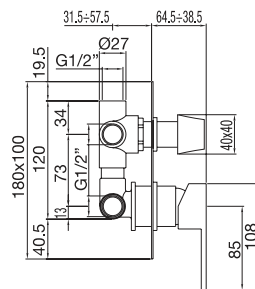

34132..

Finiture - Finishes

CR

NP

IT - Monocomando incasso doccia con deviatore e kit doccia.

GB - Built-in shower mixer with diverter and shower kit.

FR - Monocommande encastré douche avec inverseur et kit douche.

DE - Einhebelmischer Einbau-Duschen mit Umstellventil und Bausatz für Duschen.

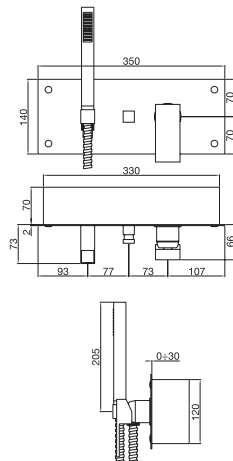

34148..

Finiture - Finishes

CR

NP

