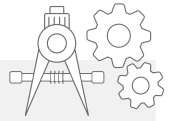

## ITALY

**IT - Gli articoli della serie Italy sono disponibili nelle finiture sotto indicate:**

CR Cromo C2 Colorato bianco

IMPORTANTE: Nella cura dei prodotti Porta & Bini si devono utilizzare soltanto i prodotti di pulizia che sono espressamente previsti per questo campo d'impiego. Non utilizzare prodotti ausiliari e attrezzi per la pulizia con effetto abrasivo, come abrasivi inadatti, spugne e panni in microfibra.

**GB - The articles included in Italy series are available in the following finishings:**

CR Chrome C2 White colored

IMPORTANT: With regard to caring for the Porta & Bini products, only use cleaning material which is explicitly provided for this type of application. Never use cleaning materials or appliances with an abrasive effect, such as unsuitable cleaning powders, sponge pads or micro fibre cloths.

**FR - Les articles de la série Italy sont disponibles en finitions indiquées ci-dessous :**

CR Chrome C2 Colorié blanc

IMPORTANT : Lors de l'entretien des articles Porta & Bini, seuls les produits de nettoyage expressément prévus pour ce type d'entretien doivent être utilisés. Ne pas utiliser d'autres produits ou d'outils de nettoyage ayant un effet abrasif, tels que les abrasifs inappropriés, éponges ou chiffons en microfibre.

**DE - Die Artikel der Serie Italy sind in den unten aufgeführten Fertigbearbeitungen erhältlich:**

CR Chrom C2 Weiß gefärbt

WICHTIG: Für die Pflege der Produkte Porta & Bini dürfen nur die Reinigungsmittel verwendet werden, welche ausdrücklich für diesen Anwendungsbereich vorgesehen sind. Keine abrasiven Hilfsprodukte und Reinigungswerkzeuge verwenden, wie ungeeignete Schleifmittel, Schwämme und Mikrofasertücher.

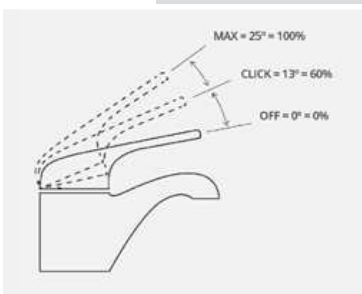
**IT - CARTUCCIA A RISPARMIO IDRICO ED ENERGETICO**

Questa cartuccia viene fornita con l'anello di regolazione della temperatura in posizione neutrale. Per risparmiare acqua ed evitare scottature, l'anello può essere spostato in modo da non far raggiungere alla cartuccia la posizione di piena erogazione dell'acqua calda. La cartuccia è provvista anche di un ottimizzatore di flusso o "click" a metà apertura della leva che fornisce un risparmio idrico ed una diminuzione di portata fino al 50%.

**GB - WATER AND ENERGY SAVING CARTRIDGE**

This cartridge is supplied with hot limit ring in the middle position. To save hot water and avoid scalding, the ring may be adjusted so the ring pin contacts the stop before the faucet handle reaches the full hot water position. Water flow optimization thanks to a mid-way stop at 60% of the lever stroke that provides up to 50% water saving.

**FR - CARTOUCHE D'ÉCONOMIE D'EAU ET D'ÉNERGIE**

La cartouche à économie d'énergie est fournie avec la bague de réglage de la température en position neutre. Afin d'économiser de l'eau et éviter les brûlures, la bague peut être déplacée de sorte que la cartouche ne puisse pas atteindre la position de la distribution maximale de l'eau chaude. La cartouche est également équipée d'un optimiseur de flux ou « click » à mi-ouverture du levier qui permet de réduire la consommation d'eau ainsi que son débit jusqu'à 50%.

**DE - WASSER- UND ENERGIESPARENDE KARTUSCHE**

Die Kartusche wird mit dem Temperatureinstellung in neutraler Position ausgeliefert. Um Wasser zu sparen und um Verbrennungen zu verhindern, kann der Ring so eingestellt werden, dass die Kartusche die Position zur vollständigen Warmwasserzufuhr nicht erreicht. Die Kartusche ist auch mit einem Durchflussoptimierer, bzw. mit einem "Klicken" in der Mitte der Hebelöffnung ausgestattet, was zu einer Wassereinsparung und zu einer Durchflussleistung von bis zu 50% führt.

**IT - SPECIFICHE TECNICHE**

- > Temperatura di utilizzo massima 80°C, consigliata 60°C.
- > Pressione di alimentazione ottimale 3 bar continui.
- > Differenza pressione massima acqua calda/fredda 1 bar consigliata la minima possibile.
- > Nel caso di pressioni oltre i 5 bar, è consigliabile installare un riduttore di pressione.

NOTA: I tubetti flessibili vengono forniti come dotazione standard per una più facile installazione; i tubetti rigidi sono disponibili come un accessorio opzionale o su previa richiesta.

Per garantire l'ottimale funzionamento del prodotto si consiglia l'installazione di rubinetti filtro sottolavabo ispezionabili Porta & Bini articoli: 00538, 00539 e 00540.

**GB - TECHNICAL SPECIFICATION**

- > Temperature range max 80°C, recommended 60°C.
- > Optimal water supply pressure 3 bar continual.
- > Difference of hot/cold pressure max 1 bar recommended minimum possible.
- > In the event of pressure over 5 bar, install a centralized pressure reducer.

NOTE: Stainless steel hoses are provided as standard equipment for easy installation; copper supply tubes are available as an optional accessory or with advance notice. In order to allow optimal product operation is recommended to connect hot and cold waterlines to the angle stop filter valves Porta & Bini items code: 00538, 00539 and 00540.

**FR - SPÉCIFICATIONS TECHNIQUES**

- > Température d'utilisation maximale 80°C, conseillée 60°C.
- > Pression d'alimentation optimale 3 bar continue.
- > Différence de pression max de l'eau chaude/froide 1 bar, la différence conseillée - la plus petite possible.
- > En cas des pressions supérieures à 5 bar, il est conseillé d'installer un réducteur de pression.

NOTE : Les tubes flexibles sont fournis avec l'équipement standard pour une installation plus facile ; les tubes rigides sont disponibles en option ou sur demande. Afin de garantir le fonctionnement optimal du produit, il est conseillé d'installer les robinets avec filtre sous lavabo inspectables Porta & Bini articles: 00538, 00539 et 00540.

**DE - TECHNISCHE SPEZIFIKATIONEN**

- > Maximale Gebrauchstemperatur 80°C, empfohlene Temperatur 60°C.
- > Der optimale Versorgungsdruck liegt bei durchgehend 3 bar.
- > Als maximaler möglicher Druckunterschied bei Heiß-/Kaltwasser wird als Mindestwert 1 bar empfohlen.
- > Bei einem Wasserdruck von über 5 bar ist es ratsam, ein Druckminderventil einzubauen.

ANMERKUNG: Die Schläuche werden zur einfacheren Installation als Standardausrüstung mitgeliefert; Die starren Rohrleitungen sind als optionales Zubehör oder auf vorhergehende Anfrage erhältlich.

Um die optimale Funktionsfähigkeit des Produktes zu gewährleisten, empfiehlt sich die Installation von inspezionierbaren Untertisch-Filtereckventilen der Firma Porta & Bini, Artikel: 00538, 00539 und 00540.

# Italy

ITALY



pag 379



pag 317



pag 406



pag 388



pag 330



pag 409



pag 362



pag 551

IT - Porta & Bini si riserva il diritto di apportare eventuali modifiche ai propri prodotti senza preavviso. Le dimensioni raffigurate all'interno delle rappresentazioni grafiche sono da ritenersi indicative e soggette a possibili variazioni. In caso di domande si prega di contattare il proprio fornitore autorizzato Porta & Bini.

GB - Porta & Bini has the right to modify its products without any notice. All dimensions are based on original specification and are subject to change and variation. Please consult your Porta & Bini Design Associate for current specifications.

FR - Porta & Bini se réserve le droit de modifier ses propres produits sans préavis. Les dimensions indiquées dans les représentations graphiques sont données à titre indicatif et sont susceptibles d'être modifiées. En cas de doutes veuillez contacter votre livreur autorisé Porta & Bini.

DE - Das Unternehmen Porta & Bini behält sich das Recht vor, Änderungen an seinen Produkten ohne vorherige Ankündigung vorzunehmen. Die in den grafischen Darstellungen dargestellten Abmessungen sind als Richtwerte zu betrachten und unterliegen möglichen Abweichungen. Bei Fragen wenden Sie sich bitte an Ihren, von Porta & Bini autorisierten Lieferanten.

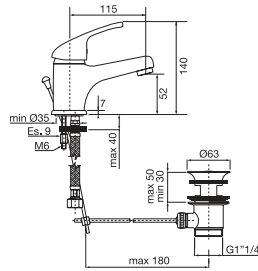

IT - Monocomando lavabo con scarico automatico.  
 GB - Single lever basin mixer with pop up waste.  
 FR - Monocommande lavabo avec décharge automatique.  
 DE - Einhebelmischer für Waschbecken mit automatischem Ablauf.

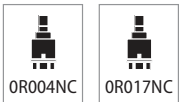

<b>22110..</b>	Finiture - Finishes
	<b>CR</b>
	<b>C2</b>

<b>22610..</b>	IT - cartuccia risparmio idrico.	<b>CR</b>
	GB - water saving cartridge.	<b>C2</b>
	FR - cartouche économiseur d'eau.	
	DE - Wassersparkartusche.	

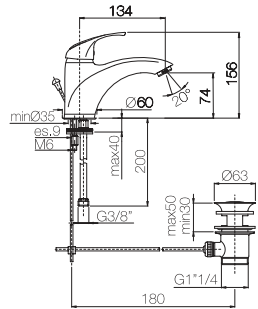

IT - Monocomando lavabo medio con scarico automatico.  
 GB - Medium single lever basin mixer with pop up waste.  
 FR - Monocommande lavabo moyen avec décharge automatique.  
 DE - Einhebelmischer Waschbecken mittelgroß mit automatischem Ablauf.

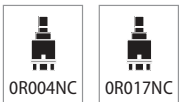

<b>22112..</b>	Finiture - Finishes
	<b>CR</b>
	<b>C2</b>

<b>22612..</b>	IT - cartuccia risparmio idrico.	<b>CR</b>
	GB - water saving cartridge.	<b>C2</b>
	FR - cartouche économiseur d'eau.	
	DE - Wassersparkartusche.	

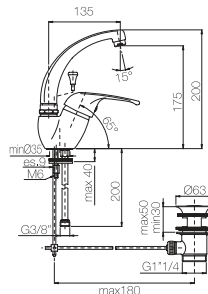

IT - Monocomando lavabo canna alta con scarico automatico.  
 GB - Single lever basin mixer high spout with pop up waste.  
 FR - Monocommande lavabo bec haut avec décharge automatique.  
 DE - Einhebelmischer für Waschbecken, hoher Lauf mit automatischem Ablauf.

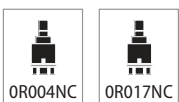

<b>22314..</b>	Finiture - Finishes
	<b>CR</b>
	<b>C2</b>

<b>22614..</b>	IT - cartuccia risparmio idrico.	<b>CR</b>
	GB - water saving cartridge.	<b>C2</b>
	FR - cartouche économiseur d'eau.	
	DE - Wassersparkartusche.	

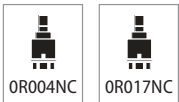
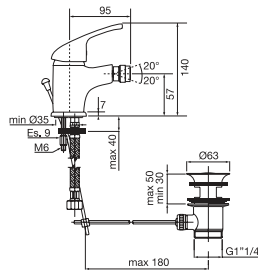

IT - Monocomando bidet con scarico automatico.  
 GB - Single lever bidet mixer with pop up waste.  
 FR - Monocommande bidet avec décharge automatique.  
 DE - Einhebelmischer für Bidet mit automatischem Ablauf.

<b>22120..</b>	Finiture - Finishes
	<b>CR</b>
	<b>C2</b>

<b>22620..</b>	Finiture - Finishes
IT - cartuccia risparmio idrico.	<b>CR</b>
GB - water saving cartridge.	<b>C2</b>
FR - cartouche économiseur d'eau.	
DE - Wassersparkartusche.	

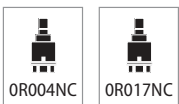
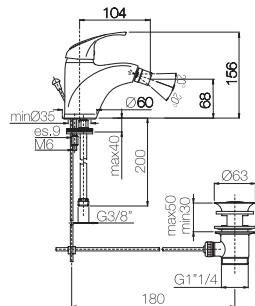

IT - Monocomando bidet medio con scarico automatico.  
 GB - Medium single lever bidet mixer with pop up waste.  
 FR - Monocommande bidet moyen avec décharge automatique.  
 DE - Einhebelmischer für Bidet, mittelgroß mit automatischem Ablauf.

<b>22122..</b>	Finiture - Finishes
	<b>CR</b>
	<b>C2</b>

<b>22622..</b>	Finiture - Finishes
IT - cartuccia risparmio idrico.	<b>CR</b>
GB - water saving cartridge.	<b>C2</b>
FR - cartouche économiseur d'eau.	
DE - Wassersparkartusche.	

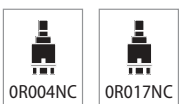
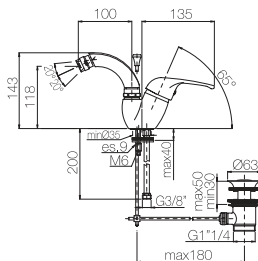

IT - Monocomando bidet canna alta con scarico automatico.  
 GB - Single lever bidet mixer high spout with pop up waste.  
 FR - Monocommande bidet bec haut avec décharge automatique.  
 DE - Einhebelmischer für Bidet, hoher Lauf mit automatischem Ablauf.

<b>22121..</b>	Finiture - Finishes
	<b>CR</b>
	<b>C2</b>

<b>22621..</b>	Finiture - Finishes
IT - cartuccia risparmio idrico.	<b>CR</b>
GB - water saving cartridge.	<b>C2</b>
FR - cartouche économiseur d'eau.	
DE - Wassersparkartusche.	

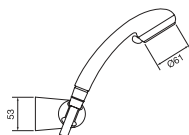
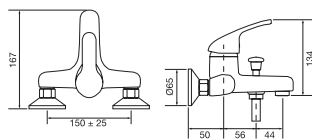

IT - Monocomando vasca esterno con kit doccia.

GB - Single lever bath mixer with shower kit.

FR - Monocommande baignoire externe avec kit douche.

DE - Externer Einhebelmischer für Badewannen mit Bausatz für Duschen.

22100..

Finiture - Finishes

CR

C2

22600..

IT - cartuccia risparmio idrico.

GB - water saving cartridge.

FR - cartouche économiseur d'eau.

DE - Wassersparkartusche.

CR

C2

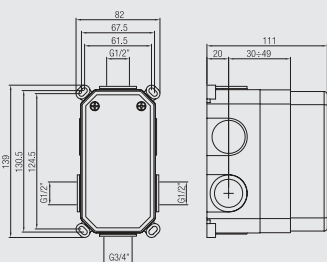

IT - Cassetta da incasso a muro universale.

GB - Universal built-in shower box.

FR - Boitier encastrable montage mural universel.

DE - Universal-Einbauspülkasten Wandmontage.

01BOXNC

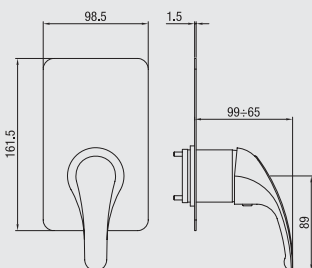

IT - Parti esterne monocomando doccia incasso.

GB - External parts built-in shower mixer.

FR - Parties externes monocommande douche encastrament.

DE - Externe Bestandteile Einhebelmischer für Duschen Einbau.

22166..

Finiture - Finishes

CR

C2

22666..

IT - cartuccia risparmio idrico.

GB - water saving cartridge.

FR - cartouche économiseur d'eau.

DE - Wassersparkartusche.

CR

C2

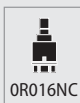

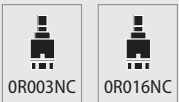
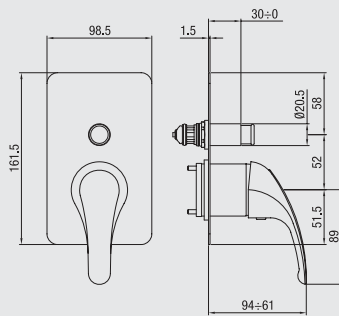

IT - Parti esterne monocomando doccia incasso con deviatore.  
 GB - External parts built-in shower mixer with diverter.  
 FR - Parties externes monocommande douche encastrement avec inverseur.  
 DE - Externe Bestandteile Einhebelmischer für Duschen Einbau mit Umstellventil.

<b>22167..</b>	Finiture - Finishes
	<b>CR</b>
	<b>C2</b>

<b>22667..</b>	Finiture - Finishes
IT - cartuccia risparmio idrico.	<b>CR</b>
GB - water saving cartridge.	<b>C2</b>
FR - cartouche économiseur d'eau.	
DE - Wassersparkartusche.	

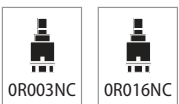
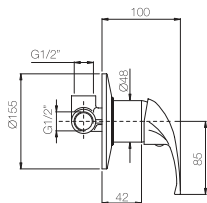

IT - Monocomando doccia incasso.  
 GB - Built-in shower mixer.  
 FR - Monocommande douche encastrement.  
 DE - Einhebelmischer für Duschen, Einbau.

<b>22130..</b>	Finiture - Finishes
	<b>CR</b>
	<b>C2</b>

<b>22630..</b>	Finiture - Finishes
IT - cartuccia risparmio idrico.	<b>CR</b>
GB - water saving cartridge.	<b>C2</b>
FR - cartouche économiseur d'eau.	
DE - Wassersparkartusche.	

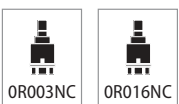
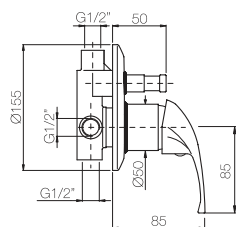

IT - Monocomando doccia incasso con deviatore.  
 GB - Built-in shower mixer with diverter.  
 FR - Monocommande douche encastrement avec inverseur.  
 DE - Einhebelmischer für Duschen, Einbau mit Umstellventil.

<b>22131..</b>	Finiture - Finishes
	<b>CR</b>
	<b>C2</b>

<b>22631..</b>	Finiture - Finishes
IT - cartuccia risparmio idrico.	<b>CR</b>
GB - water saving cartridge.	<b>C2</b>
FR - cartouche économiseur d'eau.	
DE - Wassersparkartusche.	

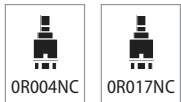
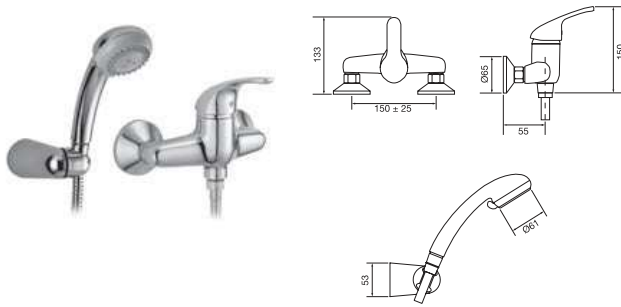

IT - Monocomando doccia esterno con kit doccia.  
 GB - External shower mixer with shower kit.  
 FR - Monocommande douche externe avec kit douche.  
 DE - Externer Einhebelmischer für Duschen mit Bausatz für Duschen.

<b>22140..</b>	Finiture - Finishes
	<b>CR</b>
	<b>C2</b>

<b>22640..</b>	
<i>IT - cartuccia risparmio idrico.</i>	<b>CR</b>
<i>GB - water saving cartridge.</i>	<b>C2</b>
<i>FR - cartouche économiseur d'eau.</i>	
<i>DE - Wassersparkartusche.</i>	

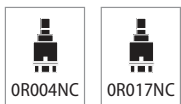
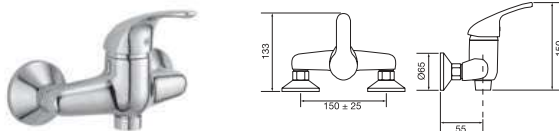

IT - Monocomando doccia esterno senza kit doccia.  
 GB - External shower mixer without shower kit.  
 FR - Monocommande douche externe sans kit douche.  
 DE - Externer Einhebelmischer für Duschen ohne Bausatz für Duschen.

<b>22141..</b>	Finiture - Finishes
	<b>CR</b>
	<b>C2</b>

<b>22641..</b>	
<i>IT - cartuccia risparmio idrico.</i>	<b>CR</b>
<i>GB - water saving cartridge.</i>	<b>C2</b>
<i>FR - cartouche économiseur d'eau.</i>	
<i>DE - Wassersparkartusche.</i>	

**PB** PORTA&BINI  
P A S S I O N F O R W A T E R

