

## FORMA

**IT - Gli articoli della serie Forma sono disponibili nelle finiture sotto indicate:**

CR	Cromo	NS	Nichel satinato
GI	Ottone lucido	GF	Grafite
NP	Nero opaco	DO	Dorato
BR	Bronzato*	RU	Rame ultrasatinato
DC	Rame scuro*	OU	Ottone ultrasatinato

\*Le collezioni prodotte con finiture spazzolate vengono realizzate interamente a mano. Tale processo conferisce alla finitura una speciale discontinuità, rendendo ogni pezzo unico ed esclusivo.

IMPORTANTE: Nella cura dei prodotti Porta & Bini si devono utilizzare soltanto i prodotti di pulizia che sono espressamente previsti per questo campo d'impiego. Non utilizzare prodotti ausiliari e attrezzi per la pulizia con effetto abrasivo, come abrasivi inadatti, spugne e panni in microfibra.

**GB - The articles included in Forma series are available in the following finishings:**

CR	Chrome	NS	Satin nickel
GI	Natural brass	GF	Graphite
NP	Black matt	DO	Gold
BR	Bronze*	RU	Ultrasatin copper
DC	Dark copper*	OU	Ultrasatin brass

\*The brushed finishing collections are made entirely by hand. This means that their discontinuous shade may be visible. These distinct characteristics contribute to making each piece unique and exclusive.

IMPORTANT: With regard to caring for the Porta & Bini products, only use cleaning material which is explicitly provided for this type of application. Never use cleaning materials or appliances with an abrasive effect, such as unsuitable cleaning powders, sponge pads or micro fibre cloths.

**FR - Les articles de la série Forma sont disponibles en finitions indiquées ci-dessous :**

CR	Chrome	NS	Nickel satiné
GI	Laiton poli	GF	Graphite
NP	Noir opaque	DO	Doré
BR	Bronzé*	RU	Cuivre ultrasatiné
DC	Cuivre foncé*	OU	Laiton ultrasatiné

\*Les collections avec des finitions brossées sont entièrement réalisées à la main. Grâce à ce procédé, la finition acquiert une discontinuité particulière en rendant chaque pièce unique et exclusive.

IMPORTANT : Lors de l'entretien des articles Porta & Bini, seuls les produits de nettoyage expressément prévus pour ce type d'entretien doivent être utilisés. Ne pas utiliser d'autres produits ou d'outils de nettoyage ayant un effet abrasif, tels que les abrasifs inappropriés, éponges ou chiffons en microfibra.

**DE - Die Artikel der Serie Forma sind in den unten aufgeführten Fertigbearbeitungen erhältlich:**

CR	Chrom	NS	Satinierter Nickel
GI	Poliertes Messing	GF	Graphitgrau
NP	Mattschwarz	DO	Vergoldet
BR	Brüniert*	RU	Ultrasatiniertes Kupfer
DC	Dunkles Kupfer*	OU	Ultrasatiniertes Messing

\*Die mit gebürsteten Oberflächen hergestellten Kollektionen werden vollständig von Hand gefertigt. Dieser Prozess verleiht dem Finish eine besondere Diskontinuität, wodurch jedes Stück einzigartig und exklusiv wird.

WICHTIG: Für die Pflege der Produkte Porta & Bini dürfen nur die Reinigungsmittel verwendet werden, welche ausdrücklich für diesen Anwendungsbereich vorgesehen sind. Keine abrasiven Hilfsprodukte und Reinigungswerkzeuge verwenden, wie ungeeignete Schleifmittel, Schwämme und Mikrofasertücher.

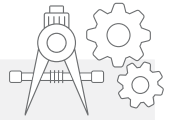
**IT - SPECIFICHE TECNICHE**

- > Temperatura di utilizzo massima 80°C, consigliata 60°C.
- > Pressione di alimentazione ottimale 3 bar continui.
- > Differenza pressione massima acqua calda/fredda 1 bar consigliata la minima possibile.
- > Nel caso di pressioni oltre i 5 bar, è consigliabile installare un riduttore di pressione.

NOTA: I tubetti flessibili vengono forniti come dotazione standard per una più facile installazione; i tubetti rigidi sono disponibili come un accessorio opzionale o su previa richiesta.

Per garantire l'ottimale funzionamento del prodotto si consiglia l'installazione di rubinetti filtro sottolavabo ispezionabili Porta & Bini articoli: 00538, 00539 e 00540.

**GB - TECHNICAL SPECIFICATION**

- > Temperature range max 80°C, recommended 60°C.
- > Optimal water supply pressure 3 bar continual.
- > Difference of hot/cold pressure max 1 bar recommended minimum possible.
- > In the event of pressure over 5 bar, install a centralized pressure reducer.

NOTE: Stainless steel hoses are provided as standard equipment for easy installation; copper supply tubes are available as an optional accessory or with advance notice.

In order to allow optimal product operation it is recommended to connect hot and cold waterlines to the angle stop filter valves Porta & Bini items code: 00538, 00539 and 00540.

**FR - SPÉCIFICATIONS TECHNIQUES**

- > Température d'utilisation maximale 80°C, conseillée 60°C.
- > Pression d'alimentation optimale 3 bar continue.
- > Différence de pression max de l'eau chaude/froide 1 bar, la différence conseillée - la plus petite possible.
- > En cas des pressions supérieures à 5 bar, il est conseillé d'installer un réducteur de pression.

NOTE : Les tubes flexibles sont fournis avec l'équipement standard pour une installation plus facile ; les tubes rigides sont disponibles en option ou sur demande.

Afin de garantir le fonctionnement optimal du produit, il est conseillé d'installer les robinets avec filtre sous lavabo inspectables Porta & Bini articles: 00538, 00539 et 00540.

**DE - TECHNISCHE SPEZIFIKATIONEN**

- > Maximale Gebrauchstemperatur 80°C, empfohlene Temperatur 60°C.
- > Der optimale Versorgungsdruck liegt bei durchgehend 3 bar.
- > Als maximaler möglicher Druckunterschied bei Heiß-/Kaltwasser wird als Mindestwert 1 bar empfohlen.
- > Bei einem Wasserdruck von über 5 bar ist es ratsam, ein Druckminderventil einzubauen.

ANMERKUNG: Die Schläuche werden zur einfacheren Installation als Standardausrüstung mitgeliefert; Die starren Rohrleitungen sind als optionales Zubehör oder auf vorhergehende Anfrage erhältlich.

Um die optimale Funktionsfähigkeit des Produktes zu gewährleisten, empfiehlt sich die Installation von inspizierbaren Untertisch-Filtereckventilen der Firma Porta & Bini, Artikel: 00538, 00539 und 00540.

# Forma

## FORMA



pag 331



pag 348

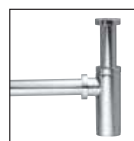

pag 532



pag 355



pag 534



pag 359



pag 533



pag 409

IT - Porta & Bini si riserva il diritto di apportare eventuali modifiche ai propri prodotti senza preavviso. Le dimensioni raffigurate all'interno delle rappresentazioni grafiche sono da ritenersi indicative e soggette a possibili variazioni. In caso di domande si prega di contattare il proprio fornitore autorizzato Porta & Bini.

GB - Porta & Bini has the right to modify its products without any notice. All dimensions are based on original specification and are subject to change and variation. Please consult your Porta & Bini Design Associate for current specifications.

FR - Porta & Bini se réserve le droit de modifier ses propres produits sans préavis. Les dimensions indiquées dans les représentations graphiques sont données à titre indicatif et sont susceptibles d'être modifiées. En cas de doutes veuillez contacter votre livreur autorisé Porta & Bini.

DE - Das Unternehmen Porta & Bini behält sich das Recht vor, Änderungen an seinen Produkten ohne vorherige Ankündigung vorzunehmen. Die in den grafischen Darstellungen dargestellten Abmessungen sind als Richtwerte zu betrachten und unterliegen möglichen Abweichungen. Bei Fragen wenden Sie sich bitte an Ihren, von Porta & Bini autorisierten Lieferanten.

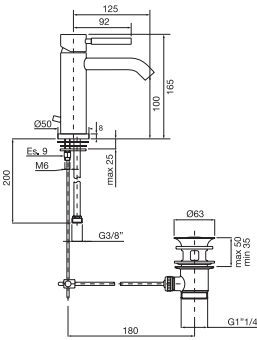

23110..

Finiture - Finishes

CR - GI

NP

BR

DC - NS - GF

DO

RU - OU

IT - Monocomando lavabo alto con piletta click-clack.  
 GB - Single lever high basin mixer with click-clack outlet.  
 FR - Monocommande lavabo haut avec bonde clic-clac.  
 DE - Hoher Einhebelmischer für Waschbecken mit Klick-Klack-Ablaufgarnitur.

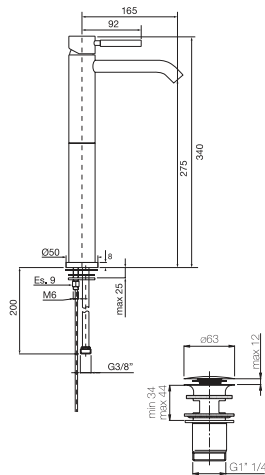

23191..

Finiture - Finishes

CR - GI

NP

BR

DC - NS - GF

DO

RU - OU

IT - Monocomando lavabo canna alta con piletta click-clack.  
 GB - Single lever basin mixer high spout with click-clack outlet.  
 FR - Monocommande lavabo bec haut avec bonde clic-clac.  
 DE - Einhebelmischer Waschbecken, hohes Rohr mit Klick-Klack-Ablaufgarnitur.

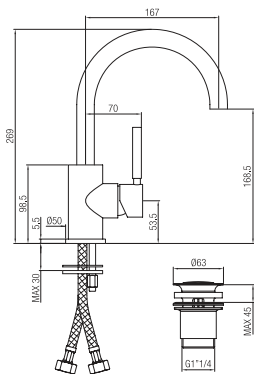

23114..

Finiture - Finishes

CR - GI

NP

BR

DC - NS - GF

DO

RU - OU

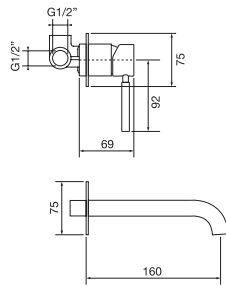

**23124..**

Finiture - Finishes

**CR - GI**

**NP**

**BR**

**DC - NS - GF**

**DO**

**RU - OU**

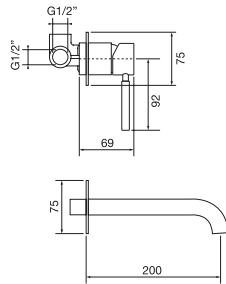

**23125..**

Finiture - Finishes

**CR - GI**

**NP**

**BR**

**DC - NS - GF**

**DO**

**RU - OU**

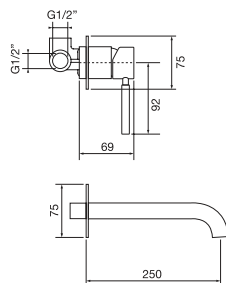

**23126..**

Finiture - Finishes

**CR - GI**

**NP**

**BR**

**DC - NS - GF**

**DO**

**RU - OU**

IT - Monocomando lavabo a muro due parti. L 160 mm.

GB - Wall single lever basin mixer two parts. L 160 mm.

FR - Monocommande lavabo montage mural deux parties. L 160 mm.

DE - Einhebelmischer Waschbecken Wandmontage zweiteilig. L 160 mm.

IT - Monocomando lavabo a muro due parti. L 200 mm.

GB - Wall single lever basin mixer two parts. L 200 mm.

FR - Monocommande lavabo montage mural deux parties. L 200 mm.

DE - Einhebelmischer Waschbecken Wandmontage zweiteilig. L 200 mm.

IT - Monocomando lavabo a muro due parti. L 250 mm.

GB - Wall single lever basin mixer two parts. L 250 mm.

FR - Monocommande lavabo montage mural deux parties. L 250 mm.

DE - Einhebelmischer Waschbecken Wandmontage zweiteilig. L 250 mm.

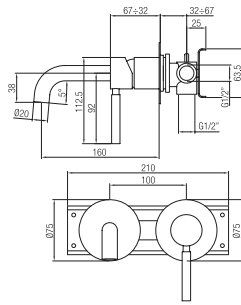

**23127..**

Finiture - Finishes

**CR - GI**

**NP**

**BR**

**DC - NS - GF**

**DO**

**RU - OU**

IT - Monocomando lavabo a muro connessione ponte. L 200 mm.  
 GB - Wall single lever basin mixer bridge connection. L 200 mm.  
 FR - Monocommande lavabo montage mural connexion pont. L 200 mm.  
 DE - Einhebelmischer Waschbecken Wandmontage Brückenanschluss. L 200 mm.

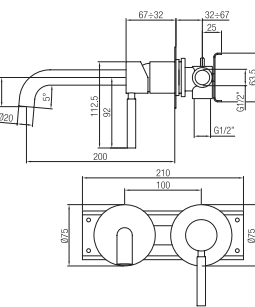

**23128..**

Finiture - Finishes

**CR - GI**

**NP**

**BR**

**DC - NS - GF**

**DO**

**RU - OU**

IT - Monocomando lavabo a muro connessione ponte. L 250 mm.  
 GB - Wall single lever basin mixer bridge connection. L 250 mm.  
 FR - Monocommande lavabo montage mural connexion pont. L 250 mm.  
 DE - Einhebelmischer Waschbecken Wandmontage Brückenanschluss. L 250 mm.

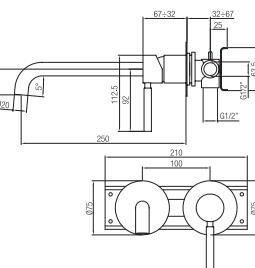

**23129..**

Finiture - Finishes

**CR - GI**

**NP**

**BR**

**DC - NS - GF**

**DO**

**RU - OU**

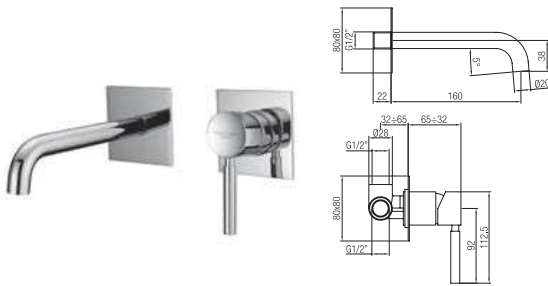

**23142..**

Finiture - Finishes

**CR - GI**

**NP**

**BR**

**DC - NS - GF**

**DO**

**RU - OU**

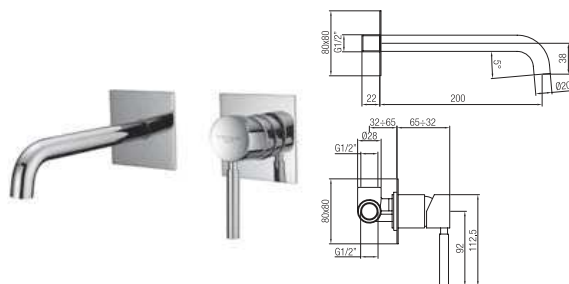

**23143..**

Finiture - Finishes

**CR - GI**

**NP**

**BR**

**DC - NS - GF**

**DO**

**RU - OU**

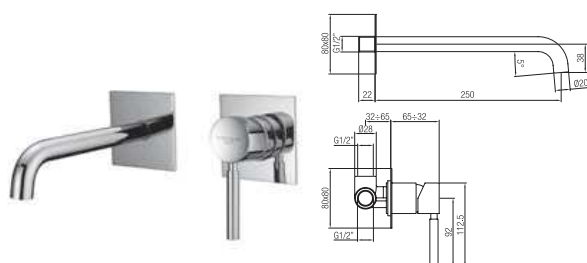

**23144..**

Finiture - Finishes

**CR - GI**

**NP**

**BR**

**DC - NS - GF**

**DO**

**RU - OU**

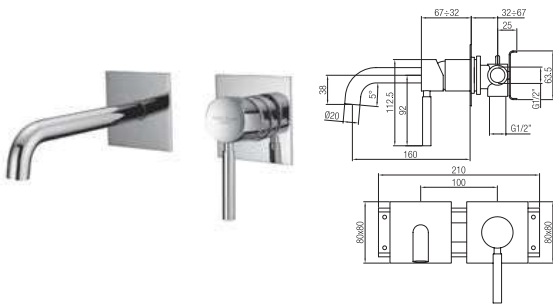

23145..

Finiture - Finishes

CR - GI

NP

BR

DC - NS - GF

DO

RU - OU

IT - Monocomando lavabo a muro connessione ponte. L 200 mm piastra quadrata.

GB - Wall single lever basin mixer bridge connection. L 200 mm square plate.

FR - Monocommande lavabo montage mural connexion pont. L 200 mm plaque carrée.

DE - Einhebelmischer Waschbecken Wandmontage Brückenanschluss. L 200 mm quadratische Platte.

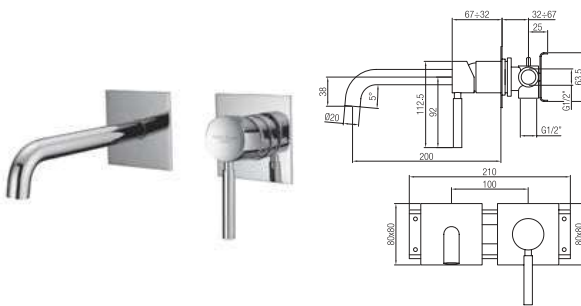

23146..

Finiture - Finishes

CR - GI

NP

BR

DC - NS - GF

DO

RU - OU

IT - Monocomando lavabo a muro connessione ponte. L 250 mm piastra quadrata.

GB - Wall single lever basin mixer bridge connection. L 250 mm square plate.

FR - Monocommande lavabo montage mural connexion pont. L 250 mm plaque carrée.

DE - Einhebelmischer Waschbecken Wandmontage Brückenanschluss. L 250 mm quadratische Platte.

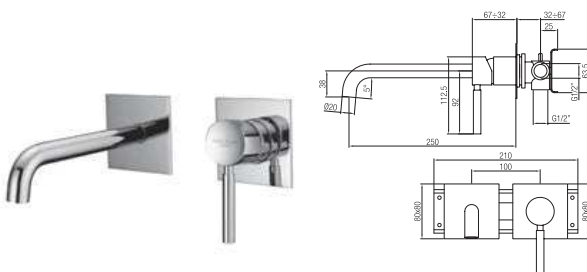

23149..

Finiture - Finishes

CR - GI

NP

BR

DC - NS - GF

DO

RU - OU

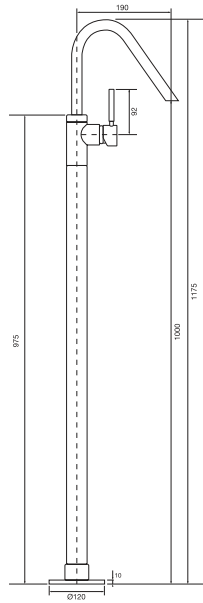

IT - Monocomando lavabo a pavimento senza scarico.  
 GB - Floor single lever basin mixer without pop up waste.  
 FR - Monocommande lavabo montage au sol sans décharge.  
 DE - Einhebelmischer Waschbecken Bodenmontage ohne Ablaufgarnitur.



**23192..**

Finiture - Finishes

**CR - GI**

**NP**

**BR**

**DC - NS - GF**

**DO**

**RU - OU**

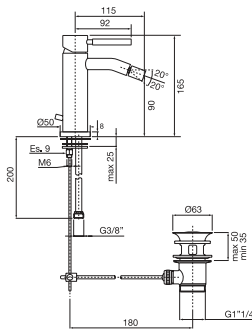

IT - Monocomando bidet con scarico automatico.  
 GB - Single lever bidet mixer with pop up waste.  
 FR - Monocommande bidet avec décharge automatique.  
 DE - Einhebelmischer für Bidet mit automatischem Ablauf.



**23120..**

Finiture - Finishes

**CR - GI**

**NP**

**BR**

**DC - NS - GF**

**DO**

**RU - OU**

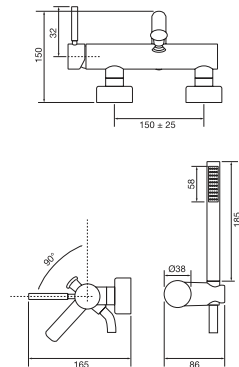

IT - Monocomando vasca esterno con kit doccia.  
 GB - Single lever bath mixer with shower kit.  
 FR - Monocommande baignoire externe avec kit douche.  
 DE - Externer Einhebelmischer für Badewannen mit Bausatz für Duschen.



**23100..**

Finiture - Finishes

**CR**

**GI**

**NP**

**BR**

**DC - NS - GF**

**DO**

**RU - OU**





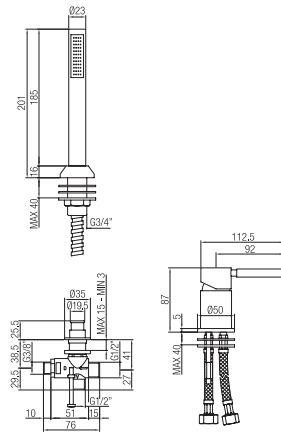

**23181..**

Finiture - Finishes

- CR
- GI
- NP
- BR
- DC - NS - GF
- DO
- RU - OU

IT - Monocomando bordo vasca con deviatore.  
 GB - Bath border mixer with diverter.  
 FR - Monocommande bord baignoire avec inverseur.  
 DE - Einhebelmischer Badewannenrand mit Umstellventil.

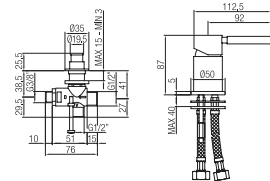

**23182..**

Finiture - Finishes

- CR - GI
- NP
- BR
- DC - NS - GF
- DO
- RU - OU

IT - Bocca d'erogazione a muro. L 120 mm.  
 GB - Wall spout with rosette. L 120 mm.  
 FR - Bec montage mural. L 120 mm.  
 DE - Auslauf, Wandmontage. L 120 mm.

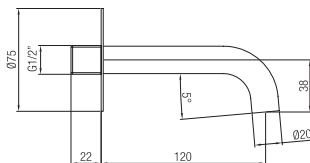

**23193..**

Finiture - Finishes

- CR - GI
- NP
- BR
- DC - NS - GF
- DO
- RU - OU

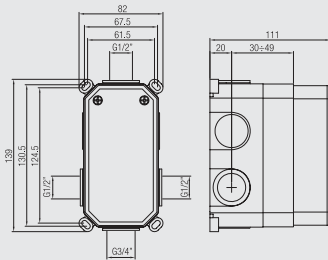

IT - Cassetta da incasso a muro universale.  
 GB - Universal built-in shower box.  
 FR - Boîtier encastrable montage mural universel.  
 DE - Universal-Einbauspülkasten Wandmontage.

**01BOXNC**

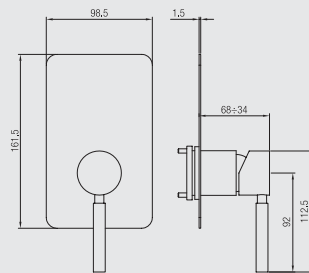

IT - Parti esterne monocomando doccia incasso.  
 GB - External parts built-in shower mixer.  
 FR - Parties externes monocommande douche encastrément.  
 DE - Externe Bestandteile Einhebelmischer für Duschen Einbau.



**23166..**

Finiture - Finishes

**CR - GI**

**NP**

**BR**

**DC - NS - GF**

**DO**

**RU - OU**

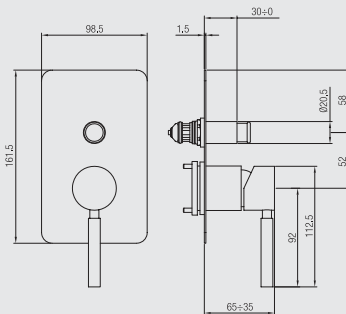

IT - Parti esterne monocomando doccia incasso con deviatore.  
 GB - External parts built-in shower mixer with diverter.  
 FR - Parties externes monocommande douche encastrément avec inverseur.  
 DE - Externe Bestandteile Einhebelmischer für Duschen Einbau mit Umstellventil.



**23167..**

Finiture - Finishes

**CR - GI**

**NP**

**BR**

**DC - NS - GF**

**DO**

**RU - OU**

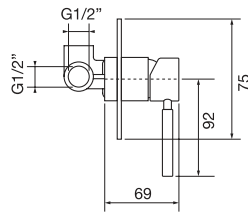

**23137..**

Finiture - Finishes

**CR - GI**

**NP**

**BR**

**DC - NS - GF**

**DO**

**RU - OU**

IT - Monocomando doccia incasso piastra slim.  
 GB - Built-in shower mixer slim plate.  
 FR - Monocommande douche encastrément plaque slim.  
 DE - Einhebelmischer für Duschen Einbau Slim Platte.

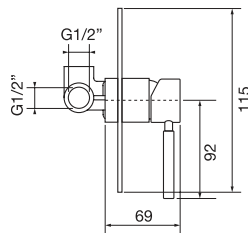

**23133..**

Finiture - Finishes

**CR - GI**

**NP**

**BR**

**DC - NS - GF**

**DO**

**RU - OU**

IT - Monocomando doccia incasso con deviatore piastra slim.  
 GB - Built-in shower mixer with diverter slim plate.  
 FR - Monocommande douche encastrément avec inverseur plaque slim.  
 DE - Einhebelmischer für Duschen Einbau mit Umstellventil Slim Platte.

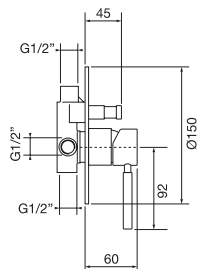

**23134..**

Finiture - Finishes

**CR - GI**

**NP**

**BR**

**DC - NS - GF**

**DO**

**RU - OU**

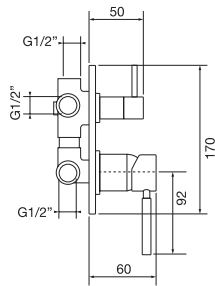

23132..

Finiture - Finishes

CR - GI

NP

BR

DC - NS - GF

DO

RU - OU

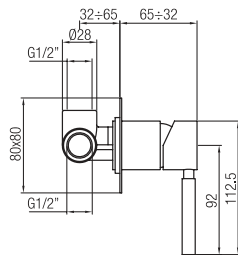

23138..

Finiture - Finishes

CR - GI

NP

BR

DC - NS - GF

DO

RU - OU

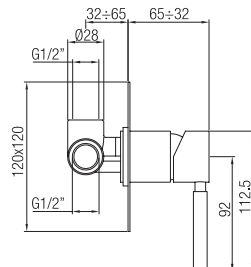

23135..

Finiture - Finishes

CR - GI

NP

BR

DC - NS - GF

DO

RU - OU

IT - Monocomando doccia incasso con deviatore tre uscite.

GB - Built-in shower mixer with diverter three outlets.

FR - Monocommande douche encastré avec inverseur trois sorties.

DE - Einhebelmischer für Duschen Einbau mit Umstellventil 3 Ausgänge.

IT - Monocomando doccia incasso piastra piccola quadrata.

GB - Built-in shower mixer small square plate.

FR - Monocommande douche encastré plaque petite carrée.

DE - Einhebelmischer für Duschen Einbau, kleine quadratische Platte.

IT - Monocomando doccia incasso piastra quadrata.

GB - Built-in shower mixer square plate.

FR - Monocommande douche encastré plaque carrée.

DE - Einhebelmischer für Duschen Einbau, quadratische Platte.

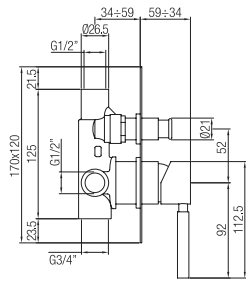

IT - Monocomando doccia incasso con deviatore piastra rettangolare.  
 GB - Built-in shower mixer with diverter rectangular plate.  
 FR - Monocommande douche encastré avec inverseur plaque rectangulaire.  
 DE - Einhebelmischer für Duschen Einbau mit Umstellventil, rechteckige Platte.



**23136..**

Finiture - Finishes

**CR - GI**

**NP**

**BR**

**DC - NS - GF**

**DO**

**RU - OU**

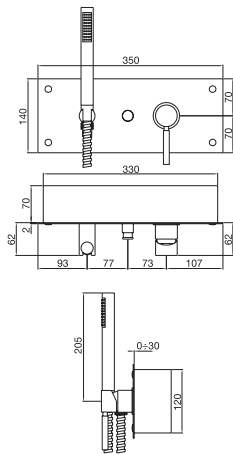

IT - Monocomando incasso doccia con deviatore e kit doccia.  
 GB - Built-in shower mixer with diverter and shower kit.  
 FR - Monocommande encastré douche avec inverseur et kit douche.  
 DE - Einhebelmischer Einbau-Duschen mit Umstellventil und Bausatz für Duschen.



**23148..**

Finiture - Finishes

**CR**

**GI**

**NP**

**BR**

**DC - NS - GF**

**DO**

**RU - OU**

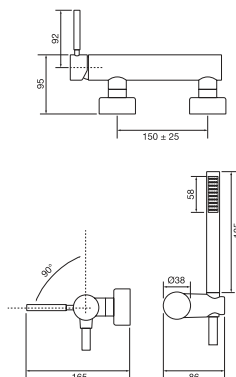

IT - Monocomando doccia esterno con kit doccia.  
 GB - External shower mixer with shower kit.  
 FR - Monocommande douche externe avec kit douche.  
 DE - Externer Einhebelmischer für Duschen mit Bausatz für Duschen.



**23140..**

Finiture - Finishes

**CR**

**GI**

**NP**

**BR**

**DC - NS - GF**

**DO**

**RU - OU**

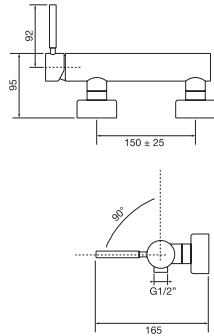

IT - Monocomando doccia esterno senza kit doccia.  
 GB - External shower mixer without shower kit.  
 FR - Monocommande douche externe sans kit douche.  
 DE - Externer Einhebelmischer für Duschen ohne Bausatz für Duschen.



23141..

Finiture - Finishes

CR - GI

NP

BR

DC - NS - GF

DO

RU - OU

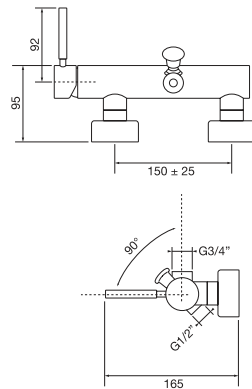

IT - Monocomando doccia esterno con deviatore integrato.  
 GB - External shower mixer with integrated diverter.  
 FR - Monocommande douche externe avec inverseur intégré.  
 DE - Externer Einhebelmischer für Duschen mit integriertem Umstellventil.



23147..

Finiture - Finishes

CR - GI

NP

BR

DC - NS - GF

DO

RU - OU

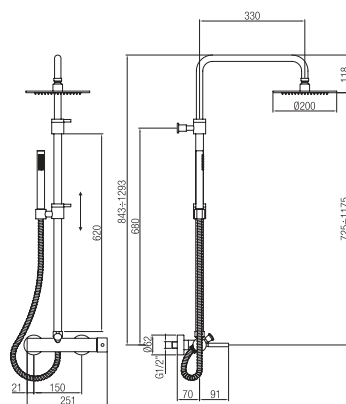

IT - Colonna doccia con miscelatore doccia deviatore integrato.  
 GB - Column shower with external shower mixer integrated diverter.  
 FR - Colonne douche avec mitigeur douche inverseur intégré.  
 DE - Duschsäule mit Mischbatterie für Duschen mit integriertem Umstellventil.



23186..

Finiture - Finishes

CR

GI

NP

BR

DC - NS - GF

DO

RU - OU



**PB** PORTA&BINI  
P A S S I O N F O R W A T E R